



FLATBED TRAILERS

O W N E R ' S M A N U A L



E X P E R I E N C E E X C E L L E N C E

For more information, visit us at
www.MACTrailer.com or call us **1-800-795-8454**

1.	Introduction And Warranty	3
1.1	Introduction.....	3
1.2	Warranty.....	3
2.	Safety	4
2.1	Safety.....	4
2.2	Towing Hazards.....	4
2.2.1	Driving Too Fast.....	4
2.2.2	Trailer Not Properly Coupled to Truck.....	5
2.2.3	Overloading.....	5
2.2.4	Improper Load Distribution.....	5
2.2.5	Shifting Cargo.....	6
2.2.6	Inappropriate Cargo.....	6
2.3	Brakes and Lights.....	6
2.4	Clearance.....	6
2.5	Maintenance.....	7
2.6	Hazards From Modifying Your Trailer.....	7
2.7	Safety Warning Labels on Your Trailer.....	7
2.8	Reporting Safety Defects.....	8
3.	Coupling Truck To Trailer	9
3.1	Providing an Adequate Truck.....	9
3.2	Trailer Information.....	9
3.3	Before Attempting To Couple Truck To Trailer.....	10
3.4	Couple Truck to Trailer.....	10
3.5	Pretrip Inspection.....	13
4.	Towing Trailer	14
4.1	Lift Axle(s).....	14
4.2	Wheels and Tires.....	15
4.3	Alignment.....	15
5.	Loading The Trailer	16
5.1	Load Trailer.....	16
6.	Uncouple Truck	17
6.1	Uncouple Truck from Trailer.....	17
7.	Accessories And Options	19
7.1	Tie Downs.....	19
7.1.1	Chain Tie Downs.....	19
7.1.2	Winches.....	19
7.1.3	Sliding Tie Down Bracket.....	19
7.2	Coil Well.....	20
8.	Inspections And Lubrication	21
8.1	Every Day.....	21
8.1.1	Inspect Trailer Deck, Chassis And Fasteners.....	21
8.2	Every Week.....	22
8.2.1	Lubrication.....	22
8.2.2	Trailer Suspension.....	22
8.2.3	Drain Trailer Air Tanks.....	22
8.2.4	Inspect, Measure And Adjust Brakes.....	23
8.3	Every Six Months.....	24
8.3.1	Air In-Line Filter.....	24
8.3.2	Glad Hand Seals and Screens.....	25
9.	Maintenance And Service	26
9.1	Tires.....	26
9.2	Wheels.....	26
9.2.1	Spoke Wheels.....	27
9.2.2	Disk Wheels.....	27
9.2.3	Wheel Ends.....	28

1. INTRODUCTION AND WARRANTY

1.1 INTRODUCTION

Read and understand this manual before using your trailer and follow all of the safety instructions. Keep all manuals provided with your trailer in a safe place inside your truck at all times.

Some components on your MAC trailer have separate instruction manuals. Where this manual indicates that you should read another manual, and you do not have that manual, contact your dealer or MAC Trailer for assistance.

Information provided in this manual was current as of the issue date. MAC Trailer reserves the right to make design changes without further notice or liability.

1.2 WARRANTY

For warranty information, see your warranty manual.

2. SAFETY

2.1 SAFETY

This Owner's Manual covers flatbed trailers produced by MAC Trailer. Before towing, operating or servicing a MAC flatbed trailer, you must read, understand and follow the instructions and safety warnings in this manual. Your trailer may not be equipped with some of the optional equipment shown in the illustrations in this manual.

The safety information in this manual is denoted by the safety alert symbol: ^

The level of risk is indicated by the following signal words.

^ DANGER

DANGER – Indicates a hazardous situation, which, if not avoided, will result in death or serious injury.

^ WARNING

WARNING – Indicates a hazardous situation, which, if not avoided, could result in death or serious injury.

^ CAUTION

CAUTION – Indicates a hazardous situation, which, if not avoided, could result in minor or moderate injury.

NOTICE

NOTICE – Indicates a situation that could result in damage to the trailer or other property.

2.2 TOWING HAZARDS

Loss of control of the truck/trailer combination can result in death or serious injury. The most common causes for loss of control are:

- Driving too fast.
- Incorrect coupling.
- Overloading.
- Improper load distribution.
- Shifting cargo.
- Not securing load properly.

2.2.1 DRIVING TOO FAST

If you drive too fast, the trailer is more likely to sway, thus increasing the possibility for loss of control.

^ WARNING

Collision Hazard.

Driving too fast for conditions can result in loss of control and may result death or serious injury.

Adjust speed down when towing trailer.

2.2.2 TRAILER NOT PROPERLY COUPLED TO TRUCK

A secure coupling is vital. Uncoupling can result in death or serious injury.

^ WARNING

Collision Hazard.

An improperly coupled trailer can result in death or serious injury.

Before towing trailer, verify that:

- **The coupler is properly secured and locked.**
- **Trailer landing gear is fully retracted.**
- **Lights and air hoses connected.**
- **Perform pre-trip inspection.**

2.2.3 OVERLOADING

An overloaded trailer can result in loss of control, which may result in death or serious injury. Overloading may also result in tire, wheel, axle or structural failure, and also increased stopping distances.

^ WARNING

Collision Hazard.

An overloaded trailer can result in death or serious injury.

Do not load a trailer so that the Gross Vehicle Weight Rating (GVWR) or Gross Axle Weight Rating (GAWR) is exceeded.

2.2.4 IMPROPER LOAD DISTRIBUTION

Improper load distribution can result to poor trailer stability and handling. Refer to “Loading the Trailer” for more information.

Uneven load distribution can cause tire, wheel, axle or structural failure, and can result in the trailer rolling over while dumping. Be sure your trailer is evenly loaded left-to-right and front-to-rear. Keep the center of gravity as low as possible.

^ WARNING

Collision Hazard.

An improperly loaded trailer can result in failure or loss of control, leading to death or serious injury.

Evenly distribute the load through out the trailer.

2.2.5 SHIFTING CARGO

Cargo must be secured to the trailer with the proper sized and rated tie downs to prevent the cargo from shifting.

^ WARNING

Collision Hazard.

Shifting cargo can result in death or serious injury.

Secure all cargo to the trailer with the proper size and rated fasteners.

2.2.6 INAPPROPRIATE CARGO

Carry only the cargo that your trailer was designed for. A trailer must not be used to carry certain items, such as people, containers of hazardous substances or containers of flammable substances.

^ WARNING

Never transport people on a trailer.

Do not transport flammable, explosive, poisonous or other dangerous materials on your trailer.

2.3 BRAKES AND LIGHTS

Be sure that the brakes and all of the lights on your trailer are functioning properly before towing your trailer.

^ WARNING

Collision Hazard.

Failure to connect the electrical connector and air hoses will result in inoperable trailer lights and brakes, and can lead to collision.

Before each tow, verify that all lights work.

2.4 CLEARANCE

^ WARNING

Collision Hazard.

Know the height, width and length of the trailer and load.

Always be aware of clearances.

2.5 MAINTENANCE

^ WARNING

Crushing Hazard.

Before performing trailer inspections, service or maintenance:

- Park trailer on firm, level surface.
- Set brakes, turn truck engine off and remove ignition key.
- Chock tires if brakes are to be released.
- Support trailer with properly rated and placed stands.

2.6 HAZARDS FROM MODIFYING YOUR TRAILER

Before making any alteration to your trailer, contact your dealer or MAC Trailer and describe the alteration you are contemplating. Altering your trailer may void the manufacturers warranty. See "Warranty" in Section 1.

2.7 SAFETY WARNING LABELS ON YOUR TRAILER

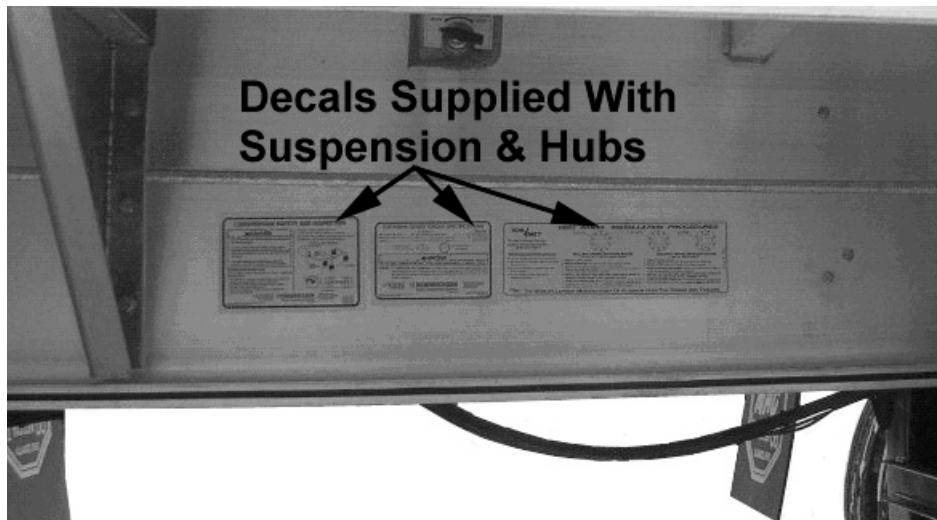

Figure 2-1 Drivers Side Rear Safety Labels



Figure 2-2 ABS Safety Label

Safety

Other decals required if equipped:

- Tire carrier decal (on top of carrier) #28800000
- Bag pressure gauge decal & high lift gate (located near suspension)
- Canada unit only (near the dolly street side) #28800532, #28800531, #28800530

^ WARNING

To protect against death or serious injury, all labels must be on the trailer and must be legible.

If any of these labels are missing or cannot be read, call MAC Trailer at 1-800-795-8454 for replacement labels.

2.8 REPORTING SAFETY DEFECTS

If you believe that your vehicle has a defect that could cause a crash or could cause injury or death, you should immediately inform the National Highway Traffic Safety Administration (NHTSA) in addition to notifying us. If NHTSA receives similar complaints, it may open an investigation, and if it finds that a safety defect exists in a group of vehicles, it may order a recall and remedy campaign. However, NHTSA cannot become involved in individual problems between you, your dealer, or MAC Trailer.

To contact NHTSA, you may either call the Vehicle Safety Hotline toll-free at 1-888-327-4236 (TTY: 1-800-424-9153), go to <http://www.safercar.gov>; or write to: Administrator, NHTSA, 400 Seventh Street, SW., Washington, DC 20590. You can also obtain other information about motor vehicle safety from <http://www.safercar.gov>.

3. COUPLING TRUCK TO TRAILER

3.1 PROVIDING AN ADEQUATE TRUCK

The truck must be matched to the Gross Vehicle Weight Rating (GVWR) of your trailer. If you already have a truck, know your trucks tow rating and make certain the trailer's rated capacity is less than or equal to the tow vehicle's rated towing capacity.

^ DANGER

Collision Hazard.

Use of an under-rated truck could result in loss of control, and can lead to death or serious injury.

Be sure your truck is rated for the Gross Vehicle Weight Rating (GVWR) of your trailer.

3.2 TRAILER INFORMATION

The Certification / VIN tag is located on the drivers side of the trailer, near the landing gear. See figure 3-1.

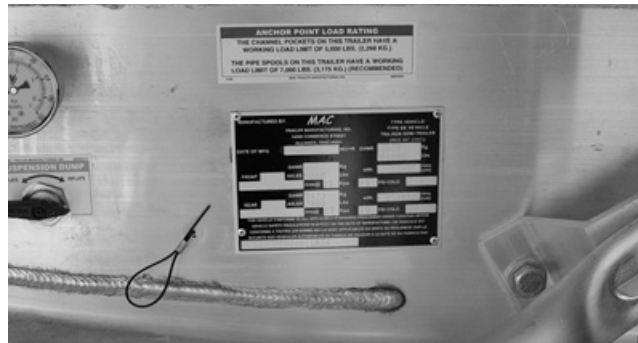

Figure 3-1 - Certification / VIN Tag Location

The trailer Certification / VIN tag contains the following information:

MANUFACTURER: MAC Trailer Manufacturing, Inc.

DATE OF MANUFACTURE: Month and year the trailer was manufactured.

GVWR WITH _____ RIMS: The Gross Vehicle Weight Rating is the maximum allowable gross weight of the trailer and its contents with the listed wheel rims.

FRONT GAWR: The Gross Axle(s) Weight Rating is the maximum gross weight that the front axle(s) can support.

REAR GAWR: The Gross Axle(s) Weight Rating is the maximum gross weight that the rear axle(s) can support.

TIRE SIZE: The tire size recommended for your trailer and load range.

PSI: The "pounds per square inch" is the tire pressure (Kilopascals / Pounds per Square Inch) measured when Cold.

VIN: The Vehicle Identification Number.

VEHICLE TYPE: Semi Trailer.

CERTIFICATION STATEMENT: "This trailer meets all the Federal Motor Vehicle Safety Standards in effect on the date of manufacture shown above".

Coupling Trailer To Truck

3.3 BEFORE ATTEMPTING TO COUPLE TRUCK TO TRAILER

1. Check the condition of the kingpin and mounting plate. Wipe the kingpin clean and inspect it for flat spots, cracks and pits.

^ WARNING

Uncoupling Hazard.

A worn, bent or damaged kingpin can fail while towing, which can result in death or serious injury.

Inspect the kingpin and kingpin plate for wear and damage. Replace a worn or damaged kingpin or kingpin plate before towing trailer.

2. Verify that the kingpin plate and fifth wheel fasteners are tight and welds are sound.

^ WARNING

Uncoupling Hazard.

A loose kingpin or fifth wheel can result in the trailer uncoupling, which can result in death or serious injury.

Verify the kingpin and fifth wheel are tight.

3. Lubricate the fifth wheel lock mechanism and verify it will move freely.
4. Clear all hoses and electrical cables from the coupling area.
5. Verify the fifth wheel locks are open.

WARNING

Crushing Hazard.

Death or serious injury may occur if the trailer drops.

Keep bystanders away from trailer while coupling.

3.4 COUPLE TRUCK TO TRAILER

1. Place wheel chocks behind the trailer tires.
2. Place the truck directly in front of the trailer. See figure 3-2. **NEVER** back under the trailer at an angle.

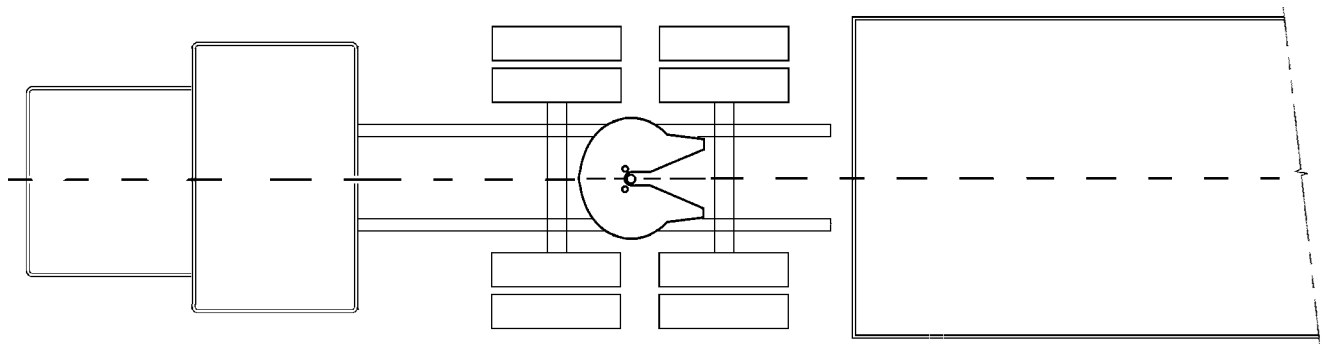

Figure 3-2 Align Truck With Trailer For Coupling

3. Back the truck until close to the trailer.

Coupling Trailer To Truck

4. Apply the truck parking brakes and place transmission in neutral.
5. Release air from truck suspension (if equipped).
6. Inspect the height of the trailer vs the fifth wheel. The kingpin plate on the front of the trailer should first contact the fifth wheel 4-6 inches rearward of the fifth wheel centerline. See figure 3-3. The trailer should raise slightly when the truck is backed under it. If the trailer is too low, the truck may strike and damage the front of the trailer. If the trailer is too high, it will not couple correctly. Adjust the landing gear as needed to achieve the correct trailer height.

^ WARNING

Uncoupling Hazard.

Trailer must be at the correct height to couple to truck.

Verify trailer is at the proper height before coupling.

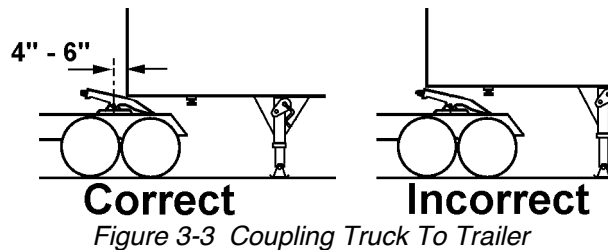

7. Verify that the kingpin and fifth wheel are aligned.
8. Slowly back the truck keeping the kingpin aligned with the fifth wheel. Continue backing until the fifth wheel locks firmly on the kingpin. Attempt to pull forward as a test to verify the fifth wheel is locked. Do not attempt to move the truck and trailer at this time. Apply the truck parking brake and place transmission in neutral.
9. Inspect the coupling. See figure 3-4. Verify there is no space between the kingpin plate and the fifth wheel. **If there is space**, the kingpin may be on top of the fifth wheel jaws. Raise the trailer with the landing gear, pull the fifth wheel release lever and pull the truck ahead. Repeat steps 6-9 again to couple the trailer correctly.

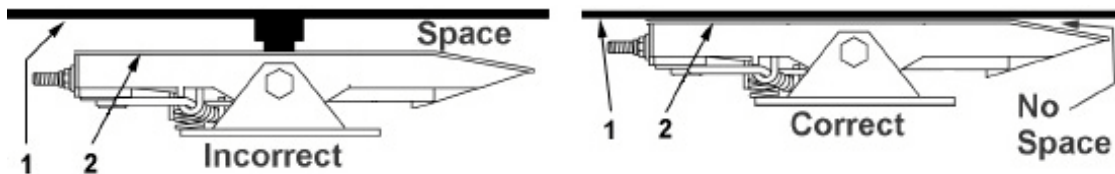

10. Go under the trailer with a flashlight and look in the back of the fifth wheel. Verify the fifth wheel jaws (A) have closed around the shank of the kingpin and the fifth wheel lock lever is in the locked position. See figure 3-5.

Coupling Trailer To Truck

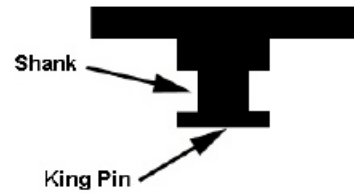
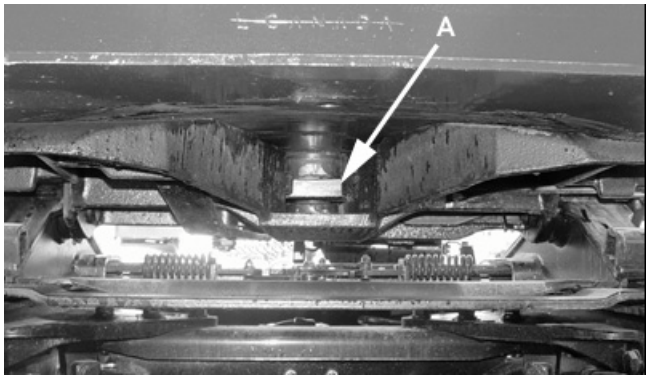

Figure 3-5 Fifth Wheel Jaws Closed Around Kingpin Shank

11. Inflate the truck suspension (if equipped).

12. Connect the supply hose to glad hand (A), service hose to glad hand (B), electrical connector and if equipped, connect hose to the lift axle glad hand. See figure 3-6.

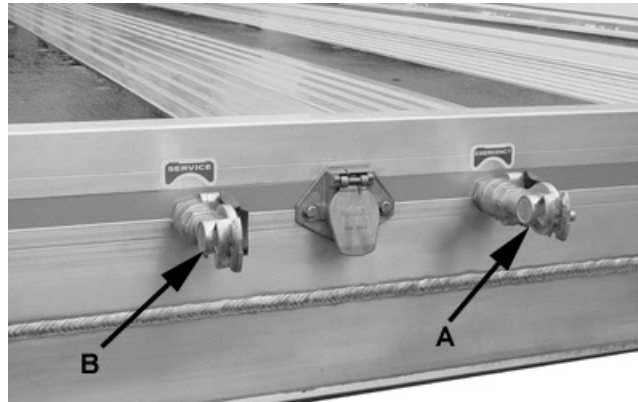

Figure 3-6 Connect Hoses And Electrical Connector

13. Raise the landing gear. MAC Trailer uses a two speed landing gear from several different manufacturers. High speed may be “in” on some models and “out” on others. Engage the crank handle (A) to the shaft and turn to retract the landing gear. Return the two speed landing gear crank handle to the storage position. See figure 3-7.



Figure 3-7 Two Speed Landing Gear

Coupling Trailer To Truck

14. Press the trailer air supply valve in the truck to fill the trailer air tanks. Do not release parking brakes.

15. Perform pretrip inspection. See section 3.5.

3.5 PRETRIP INSPECTION

Perform the inspections and checks before towing trailer:

- Check all lights for operation.
- Check that ABS light on street side rear corner of the trailer is not illuminated.
- Check that all safety decals are in place and in good, readable condition.
- Check that all reflectors are in place and in good condition.
- Check air pressure on all tires. Air pressure is listed on the Certification/VIN tag.
- Check and inspect all tires. If a tire has a bald spot, bulge, cut or cords showing, replace the tire(s) before towing trailer.
- Check wheel lug torque. See the Maintenance Section of this manual.
- Check the wheel hubs for signs of lubricant leakage.
- Check for broken or missing leaf springs or verify that air suspension springs are inflated.
- Check electrical harness and air hoses from truck for damage.
- Listen for air leaks in hoses and air suspension (if equipped).
- Check brakes for wear and adjustment, and verify the brakes function properly.

Repair or replace any worn, damaged, leaking, broken or non-functioning items before towing the trailer.

4. TOWING TRAILER

4.1 LIFT AXLE(S)

Your trailer can be equipped with one or more lift axles and may be equipped with a regulator valve. With trailer loaded, the axle(s) are lowered to help carry and distribute the load forces on the trailer. Turn the valve (A) to set the air pressure to the desired level. See figure 4-1.

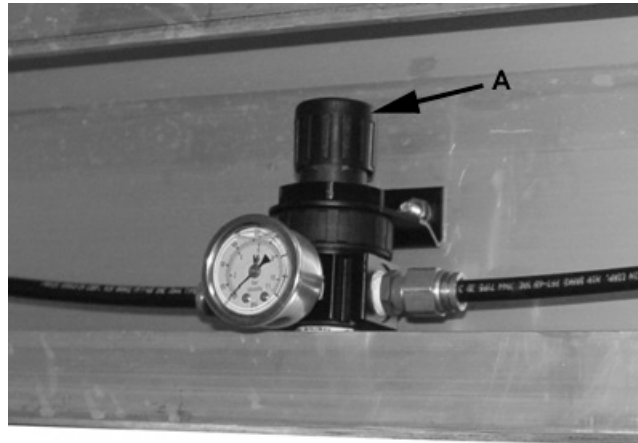

Figure 4-1 Lift Axle Regulator Valve

Use the correct chart below for the axle(s) on your trailer to set the air pressure.

AAL,AAT & AAZNT C-20901,C-23611, C-23612, C-23721, C-23748

SUSPENSION LOAD SCALE INTRAAX 250			
GAUGE		LOAD PER AXLE	
24 PSI	165 KPA	7000 LB	3175 KG
32 PSI	221 KPA	9000 LB	4082 KG
40 PSI	276 KPA	11000 LB	4990 KG
48 PSI	331 KPA	13000 LB	5897 KG
56 PSI	386 KPA	15000 LB	6804 KG
65 PSI	448 KPA	17000 LB	7711 KG
72 PSI	496 KPA	19000 LB	8618 KG
80 PSI	552 KPA	21000 LB	9526 KG
88 PSI	607 KPA	23000 LB	10433 KG
96 PSI	662 KPA	25000 LB	11340 KG

5-5 MAC TRAILER MANUFACTURING INC. 28800529

AAL,AATC-25871,C-23611, C-25872 & C-25873

SUSPENSION LOAD SCALE INTRAAX 300			
GAUGE		LOAD PER AXLE	
30 PSI	207 KPA	10000 LB	4536 KG
37 PSI	255 KPA	12000 LB	5443 KG
44 PSI	303 KPA	14000 LB	6350 KG
51 PSI	352 KPA	16000 LB	7258 KG
58 PSI	400 KPA	18000 LB	8165 KG
64 PSI	441 KPA	20000 LB	9072 KG
71 PSI	490 KPA	22000 LB	9979 KG
78 PSI	538 KPA	24000 LB	10886 KG
85 PSI	586 KPA	26000 LB	11794 KG
92 PSI	634 KPA	28000 LB	12701 KG
99 PSI	683 KPA	30000 LB	13608 KG

5-5 MAC TRAILER MANUFACTURING INC. 28800530

With the trailer empty, raise the axle(s) off the surface by relieving the air pressure on the lift axles.

^ WARNING

Collision Hazard.

An empty trailer with the lift axle(s) in the down position can be unstable while towing, which can result in loss of control.

Raise the lift axle(s) off the surface on an empty trailer before towing.

4.2 WHEELS AND TIRES

Uneven tread wear can be caused by tire imbalance, axle misalignment or improper inflation. If you observe uneven tread wear, take the trailer to an authorized truck/trailer service center for diagnosis. Trailer wheels and lugs are subjected to high side loads. This can cause the wheel lugs to become loose. Check to be certain wheel lugs are tightened to 450-500 lb ft of torque. Refer to the maintenance section for the proper tightening procedure. Failure to perform this check may result in a wheel parting from the trailer, and a crash leading to death or serious injury. You must use a torque wrench to obtain the proper tightening of the lug nuts.

4.3 ALIGNMENT

Properly aligned trailer axles optimize fuel economy and driveability, and help prevent excessive tire wear. A perfect alignment scenario has all trailer wheels parallel to one another and perpendicular to the centerline of the trailer. However due to uncontrollable factors, this perfect scenario is often an unreasonable expectation. A more likely alignment scenario has the trailer wheels parallel within a very small tolerance range to one another and perpendicular within a very small tolerance range to the centerline of the trailer. There are two important trailer axle angles that must be kept within recommended tolerance ranges: thrust angle and scrub angle. These angles, when out of tolerance, can lead to increased rolling resistance, excessive tire wear and can contribute to trailer “dog tracking.” Dog tracking is a condition where the trailer does not follow or track directly behind the truck as the vehicle is being operated in a straight line and is influenced by body rail alignment, king pin location, axle side-to-side location, and other things. If realignment is necessary, take the trailer to your dealer or an authorized trailer service center.

5. LOADING THE TRAILER

Improper trailer loading causes many accidents and deaths. To safely load a trailer, you must consider the overall load weight and load distribution.

The load distribution must be such that no component part of the trailer is loaded beyond its rating. You must be sure that the load distribution does not exceed the rating of the tires, wheels and axles.

^ WARNING

Collision Hazard.

An overloaded trailer can result in death or serious injury.

Do not load a trailer so that the Gross Vehicle Weight Rating (GVWR) or Gross Axle Weight Rating (GAWR) is exceeded.

5.1 LOAD TRAILER

1. Place the load onto the trailer, distributing the load evenly on the trailer.
2. Weigh the trailer to be sure you have not exceeded the weight capacity of the trailer, tires, axles and wheels.
3. Fasten load to the trailer with the proper size and rated tie downs
3. All loaded trailers should be covered with a tarp.

6. UNCOUPLE TRUCK

6.1 UNCOUPLE TRUCK FROM TRAILER

1. Park the trailer on a firm level surface.
2. Set the parking brakes.
3. If trailer is loaded, place blocks or pads under landing gear legs to prevent settling.
4. MAC Trailer uses a two speed landing gear from several different manufacturers. High speed may be “in” on some models and “out” on others. High speed is used only when landing gear is off the ground. Engage the crank handle (A) and lower the landing gear until it makes firm contact with the ground, blocks or pads. Switch to low gear and crank an additional 4-8 turns. See figure 6-1.

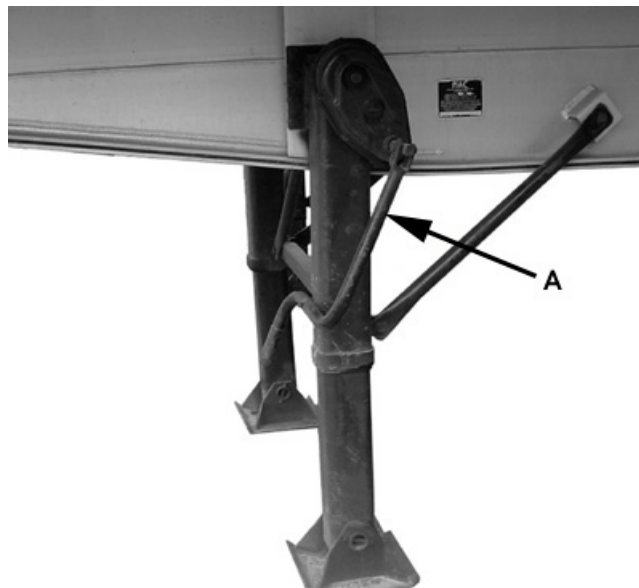

Figure 6-1 Two Speed Landing Gear

5. Disconnect the supply hose from glad hand (A), service hose from glad hand (B), electrical connector, and if equipped, disconnect hose from the lift axle glad hand. See figure 6-5.



Figure 6-2 Disconnect Hoses And Electrical Connector

6. Pull the fifth wheel release lever.
7. Release air in truck suspension (if equipped) and pull truck forward until fifth wheel comes out from under the trailer.

Uncouple Truck

8. Stop with truck frame under trailer. This will prevent the trailer from falling to the ground if the landing gear should collapse or sink.
9. Apply parking brake and place transmission in neutral.
10. Make sure ground is supporting trailer. Make sure landing gear is not damaged.
11. Check the area and drive truck forward until clear of trailer.

7. ACCESSORIES AND OPTIONS

7.1 TIE DOWNS

7.1.1 CHAIN TIE DOWNS

Your trailer may be equipped with chain tie downs located along the outer rail of the trailer. See figure 7-1. The chain load rating is listed on a decal located near the VIN tag.



Figure 7-1 Trailer Equipped With Chain Tie Downs

7.1.2 WINCHES

Your trailer may be equipped with under rail or rub rail winches. See figure 7-2. The winch load rating is listed on a decal located near the VIN tag.

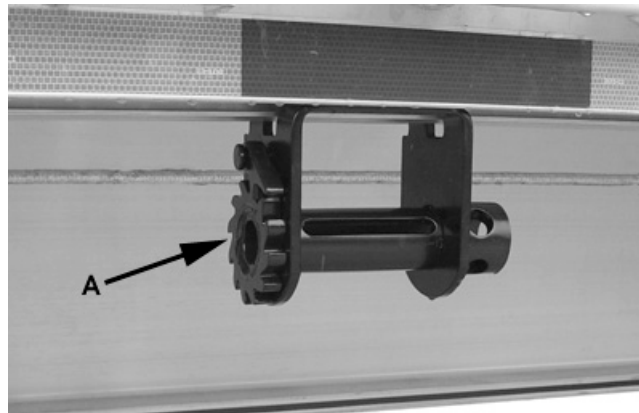

Figure 7-2 Trailer Equipped With Under Rail Winches

7.1.3 SLIDING TIE DOWN BRACKET

Your trailer may be equipped with an integrated track to accept sliding tie down brackets. See figure 7-3. The rail and bracket load rating is listed on a decal located near the VIN tag.

Options And Accessories

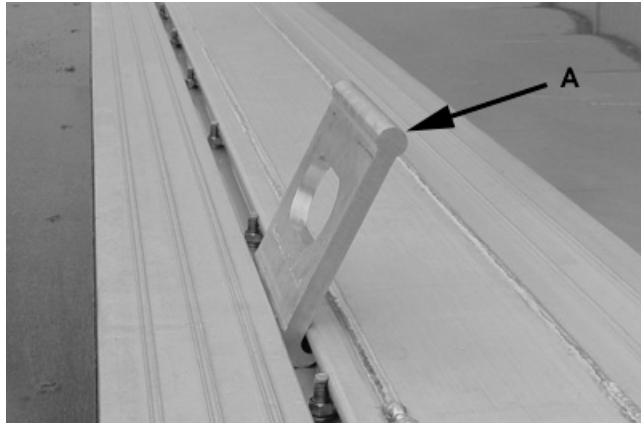

Figure 7-3 Trailer Equipped With Integrated Winch Track And Sliding Tie Downs

7.2 COIL WELL

Your trailer may be equipped with a recessed coil well. See figure 7-2.

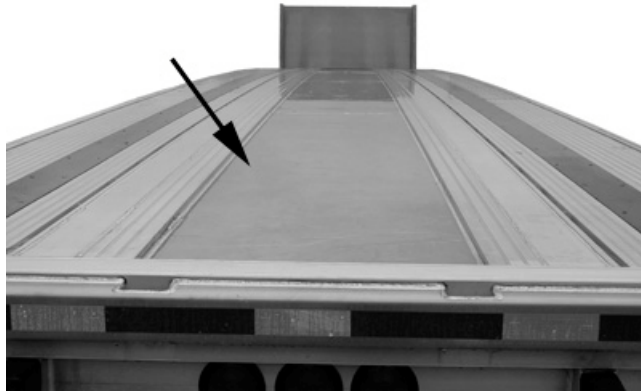

Figure 7-4 Trailer Equipped With Coil Well

8. INSPECTIONS AND LUBRICATION

Routine inspections, maintenance and service must be performed on your trailer on a regular basis to insure safe and reliable operation. Inspections can be performed by a person trained in spotting potential problems. Service and repairs must be performed by a trained, qualified technician.

Note: In addition to this manual, also check the relevant component manufacturer's manual.

^ WARNING

Crushing Hazard.

Before performing trailer inspections, service or maintenance:

- **Park trailer on firm, level surface.**
- **Set parking brakes, turn truck engine off and remove ignition key.**
- **Chock tires if brakes are to be released.**
- **Support trailer with properly rated and placed stands.**

8.1 EVERY DAY

Perform the inspections and checks before towing trailer. This list is also covered in the pre-trip inspection:

- Check all lights for proper operation.
- Check that ABS light on street side rear corner of the trailer is not illuminated.
- Check that all safety decals are in place and in good, readable condition.
- Check that all reflectors are in place and in good condition.
- Check air pressure on all tires. Air pressure is listed on the Certification/VIN tag.
- Check and inspect all tires. If a tire has a bald spot, bulge, cut or cords showing, replace the tire(s) before towing trailer.
- Check wheel lug torque. See Section 9-3.
- Check the wheel hubs for signs of lubricant leakage.
- Check for broken or missing leaf springs or verify that air suspension springs are inflated.
- Check electrical harness and air hoses from truck for damage.
- Listen for air leaks in hoses and air suspension (if equipped).
- Check brakes for wear and verify the brakes function properly.

Repair or replace any worn, damaged, leaking, broken or non-functioning items before towing the trailer.

8.1.1 INSPECT TRAILER DECK, CHASSIS AND FASTENERS

1. Inspect the trailer deck and chassis for damage daily.
2. Inspect all of the fasteners, welds and structural frame members for bending and other damage, cracks, or failure. Repair or replace any damaged fastener and repair the frame member. If you have any questions about the condition or method of repair of fasteners or frame members, get the recommendation of, or have the repair done by MAC Trailer or your dealer. Welds must be repaired by a qualified technician.

^ WARNING

Broken or damaged fasteners or welds can cause injury or damage to trailer and contents.

Inspect for and repair all damaged parts.

Inspections And Lubrication

8.2 EVERY WEEK

8.2.1 LUBRICATION

Lubricate the trailer grease fittings at least once per week.

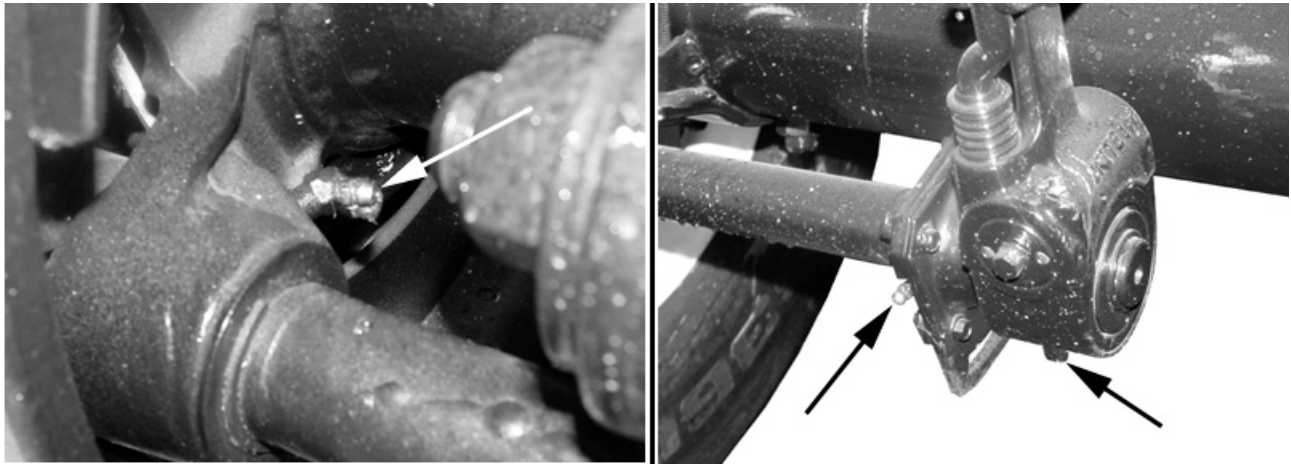

Figure 8-1 Slack Adjusters And Brake Arms Grease Fittings



Figure 8-2 Steerable Axle Grease Fittings

8.2.2 TRAILER SUSPENSION

If equipped with air ride suspension, inspect the air springs for damage. If equipped with leaf spring suspension, inspect for broken springs and equal spring arch.

8.2.3 DRAIN TRAILER AIR TANKS

Drain moisture from trailer air tanks by opening petcock (A) on the bottom of each air tank. See figure 8-3. Close petcocks after draining.

Inspections And Lubrication

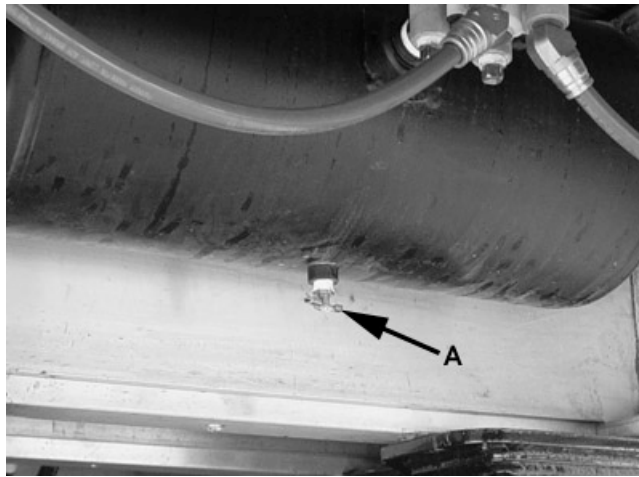

Figure 8-3 Drain Trailer Air Tanks

8.2.4 INSPECT, MEASURE AND ADJUST BRAKES

Inspect and measure the brake linings. Replace with a quality shoe and lining if contaminated, cracked or if the lining is worn to less than $\frac{1}{4}$ inch thickness at any point. See figure 8-4.

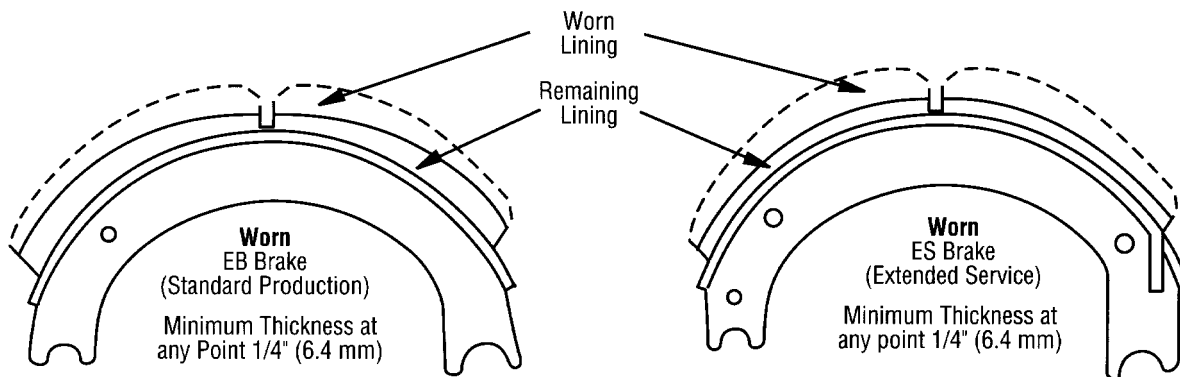

Figure 8-4 Measure Brake Lining

Chock tires and release brakes. Measure the distance (A) with brakes released. See figure 8-5. Use a lever to move slack adjuster until brakes contact the drum and measure the distance (B). Subtract distance A from distance B. The result is the free stroke. Adjust slack adjuster so the free stroke is $\frac{3}{8}$ – $\frac{5}{8}$ inch on each slack adjuster.

Inspections And Lubrication

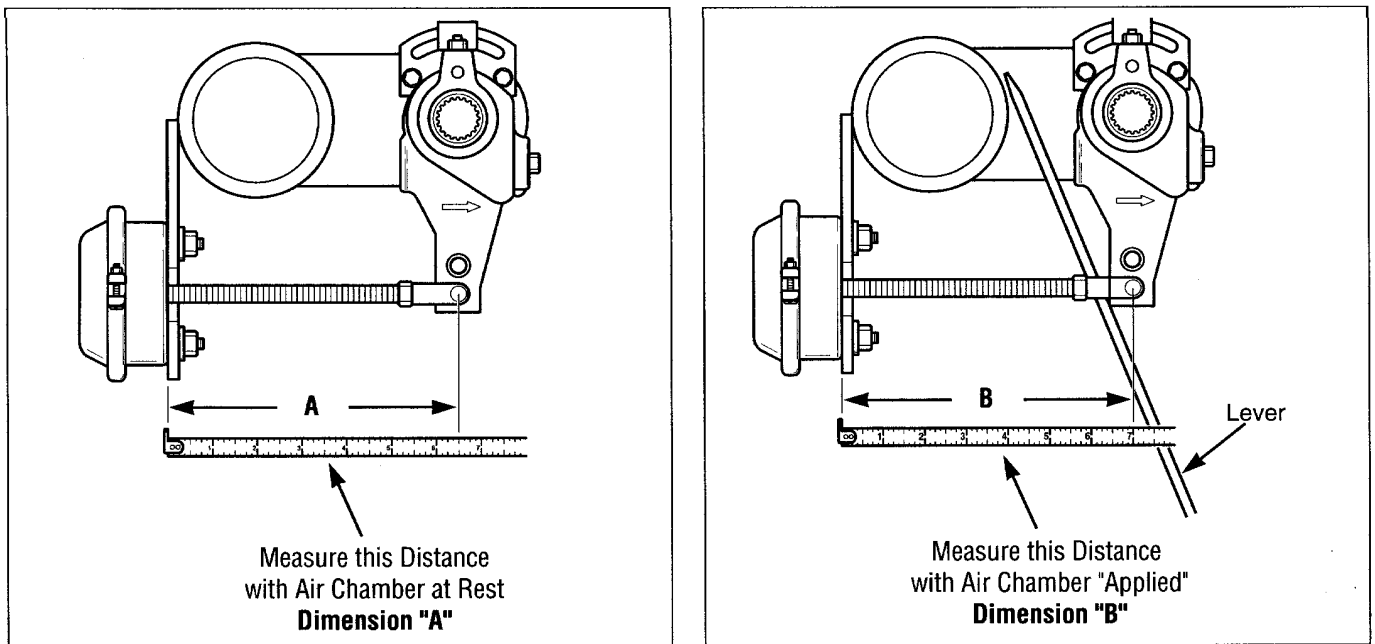

Figure 8-5 Adjust Slack Adjusters

8.3 EVERY SIX MONTHS

8.3.1 AIR IN-LINE FILTER

Your trailer is equipped with air inline filters. Filters are mounted on the inside of the frame rail. Every six months, relieve the air pressure in the trailer air tanks and remove the cap (A) and filter screen (B). See figure 8-6. Clean and install filter screen and cap.

^ WARNING

Trailer air system is under pressure.

Cap and screen can shoot out with force.

Relieve air in the trailer air system before removing cap and screen.

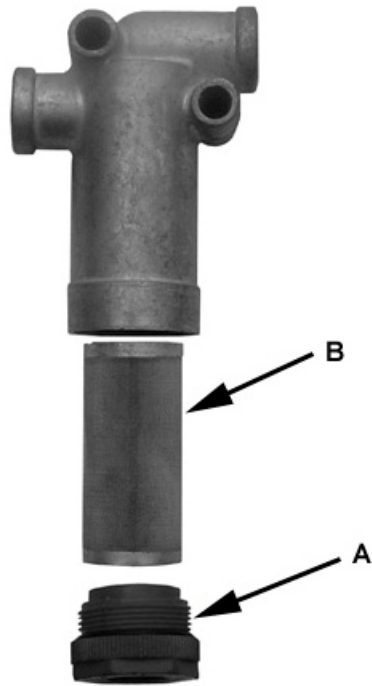

Figure 8-6 Air In-Line Filter

8.3.2 GLAD HAND SEALS AND SCREENS

Inspect all glad hand seals (A) and screens (B) (if equipped) for damage and wear. Replace if damaged or worn. See figure 8-7.

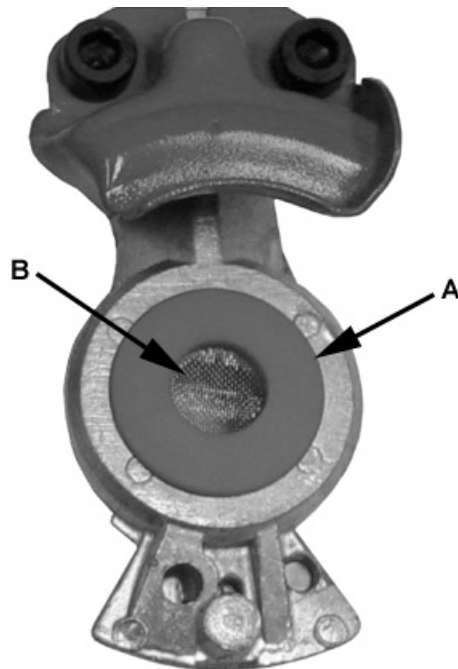

Figure 8-7 Glad Hand Seals And Screens

9. MAINTENANCE AND SERVICE

MAC Trailer uses components on their trailers such as landing gear, axle assemblies, tires and rims, which are produced by other manufacturers. Refer to the OEM manufacturer's information for specific maintenance instructions. If you do not have the manufacturers information, contact your dealer or MAC Trailer for assistance.

Routine inspections, maintenance and service must be performed on your trailer on a regular basis to insure safe and reliable operation. Inspections can be performed by a person trained in spotting potential problems. Service and repairs must be performed by a trained, qualified technician.

Note: In addition to this manual, also check the relevant component manufacturer's manual.

^ WARNING

Crushing Hazard.

Before performing trailer inspections, service or maintenance:

- **Park trailer on firm, level surface.**
- **Set parking brakes, turn truck engine off and remove ignition key.**
- **Chock tires if brakes are to be released.**
- **Support trailer with properly rated and placed stands.**

9.1 TIRES

Before each tow, be sure the tire pressure is at the value indicated on the Certification / VIN label. Tire pressure must be checked while the tire is cold. Do not check the tire pressure immediately after towing the trailer. Allow at least three hours for a tire to cool, if the trailer has been towed for as much as one mile. Replace tires that have the wear bands showing before towing trailer.

A bubble, cut or bulge in a side wall can result in a tire blowout. Inspect both side walls of each tire for any bubble, cut or bulge; and replace a damaged tire before towing the trailer.

^ WARNING

Collision hazard.

Worn, damaged or under-inflated tires can cause loss of control, injury and damage.

Check tires before towing trailer.

9.2 WHEELS

Whenever tires/wheels are removed, check the condition of the wheel, wheel lugs, hubs and studs. Replace any damaged, corroded or worn parts. Use the correct wheel lugs and wedges (if equipped) for your trailer.

^ WARNING

Wheel Failure Hazard.

- **Never weld on wheel or hub for any reason**
- **Never install aluminum wheels on an axle designed for steel wheels. The stud length is greater for aluminum wheels than steel wheels.**
- **Always use the correct lugs and wedges (if equipped).**

Maintenance And Service

9.2.1 SPOKE WHEELS

Lug nuts are prone to loosen right after a wheel is mounted to a hub. When driving on a remounted wheel, check to see if the lug nuts are tight after the first 50-100 miles of driving and weekly thereafter.

When removing a wheel from a trailer equipped with spoke wheels, care must be taken to avoid injury.

^ WARNING

Flying Projectile Hazard.

Wedges can fly out with force when removing wheel

Partially loosen wheel lugs and relieve tension on wedges before removing wheel lugs.

Loosen the wheel lugs but do not remove at this time. With the wheel lugs loose, strike the wedges with a hammer to free tension on wedges. Now the wheel lugs and wedges can be removed.

Install wheel, wedges and lugs. Rotate the wheel and set runout to a maximum of 1/8 inch. Evenly tighten lugs to 200-250 lb/ft of torque.

^ WARNING

Wheel Failure Hazard.

Lug nuts are prone to loosen after being first assembled. Death or serious injury can result.

Check lug nuts for tightness on a new trailer, and after re-mounting a wheel after the first 50-100 miles and weekly thereafter.

NOTICE

Trailer Damage.

Studs, lugs and wheels can be damaged by over tightening.

Do not over tighten wheel lugs.

9.2.2 DISK WHEELS

Lug nuts are prone to loosen right after a wheel is mounted to a hub. When driving on a remounted wheel, check to see if the lug nuts are tight after the first 50-100 miles of driving and weekly thereafter.

^ WARNING

Lug nuts are prone to loosen after being first assembled. Death or serious injury can result.

Check lug nuts for tightness on a new trailer, and after re-mounting a wheel after the first 50-100 miles and weekly thereafter.

1. Place two drops of oil to a point between the nut and flange and two drops to the two or three threads at the end of each wheel stud.

Maintenance And Service

2. Tighten to 50 lb/ft of torque in the sequence shown in figure 9-1.
3. Tighten to 450-500 lb/ft of torque in the sequence shown in figure 9-1.

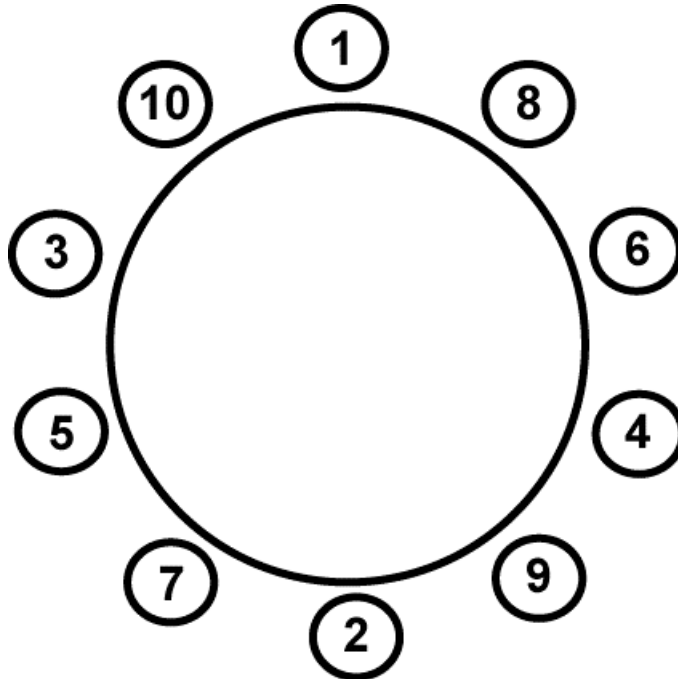

Figure 9-1 Wheel Lug Torque Sequence

9.2.3 WHEEL ENDS

Your trailer may be equipped with oil bath (A), grease packed (B) or Hendrickson Long-Lift System™ (HLS™) (C) wheel ends. See figure 9-2.



Figure 9-2 Wheel End Options

Oil bath style wheel ends (A) use an approved drive axle lubricant gear oil for lubrication. Remove the rubber plug. Use a lubricant meeting MIL-L-2105D specifications. Either 80W-90 mineral based or 75W-90 synthetic lubricant is acceptable. Do not mix lubricants. Add lubricant to the bottom full line on hub cap. Install rubber plug.

Grease packed wheel ends (B) use wheel bearing grease for lubrication. Check the axle manufacturers information regarding service and maintenance intervals.

Hendrickson Long-Life System™ (HLS™) wheel ends (C) are factory lubricated with a synthetic grease. Do not add lubricant, wheel end is factory lubricated. Do not attempt to adjust bearings, they are preset at the factory. Hub removal will void the warranty. Do not remove the (HLS™) hub cap without first contacting Hendrickson.



MAC Trailer Enterprises Corporate Office
14599 Commerce Street, Alliance, Ohio 44601
800-795-8454

MAC Service • 800-297-7986
MAC Aftermarket Parts • 800-647-9424



Follow us on    

www.MACTrailer.com